

PROJECT DESCRIPTION: SINGLE STORY 1 BEDROOM EXPANDABLE CONTAINER HOUSE

PROJECT ADDRESS:

CLIENT NAME: CONFAB PORTABLE HOMES

ACTUAL BUILDING AREA: 4.888m X 12.192m, 59.594 SQ.M.

DRAWING LIST

MH-001 LAYOUT PLAN – FLOOR PLAN

MH-002 LAYOUT PLAN – FLOORING

MH-003 LAYOUT PLAN – CEILING

MH-004 ELECTRICAL PLAN – POWER POINTS LOCATION

MH-005 ELECTRICAL PLAN – POWER POINTS LAYOUT

MH-006 INTERIOR ELEVATION – POWER POINTS LOCATION (C SIDE)
/ POWER POINTS LOCATION (KITCHEN BACKWALL)

MH-007 ELECTRICAL PLAN – RCP

MH-008 ELECTRICAL PLAN – ELECTRICAL PANEL

MH-009 PLUMPING – WASTE WATER LINE

MH-010 PLUMPING – COLD WATER SUPPLY

MH-011 PLUMPING – HOT WATER SUPPLY

MH-012 EXTERIOR ELEVATION – A SIDE (CLOSE STATE)

MH-013 EXTERIOR ELEVATION – A SIDE (OPEN STATE)

MH-014 EXTERIOR ELEVATION – B SIDE (OPEN STATE) / B SIDE (CLOSE STATE)

MH-015 EXTERIOR ELEVATION – C SIDE

MH-016 EXTERIOR ELEVATION – D SIDE

MH-017 CROSS SECTION – B-D SIDE HEADROOM / B-D SIDE BATHROOM HEADROOM

MH-018 CROSS SECTION – B-D SIDE INSULATION DETAILS

MH-019 OVERHEAD CUPBOARDS – FRONT VIEW / SIDE VIEW / INNER LAYOUT

MH-020 KITCHEN BENCH – TOP VIEW/ FRONT VIEW / SIDE VIEW

MH-021 CLOSET – TOP VIEW/ FRONT VIEW / INNER LAYOUT

DISCLAIMER:THE PRODUCT WILL BE MANUFACTURED STRICTLY IN ACCORDANCE WITH THE APPROVED DRAWINGS. ONCE THE CLIENT HAS SIGNED OFF ON THE DESIGN, PRODUCTION WILL COMMENCE ANY DESIGN MODIFICATIONS REQUESTED BY THE CLIENT DURING THE PRODUCTION PROCESS WILL BE SUBJECT TO ADDITIONAL COSTS AND MAY RESULT IN DELAYS. THE CLIENT SHALL BEAR FULL RESPONSIBILITY FOR ANY SUCH EXPENSES AND SCHEDULE ADJUSTMENTS.
Flooring

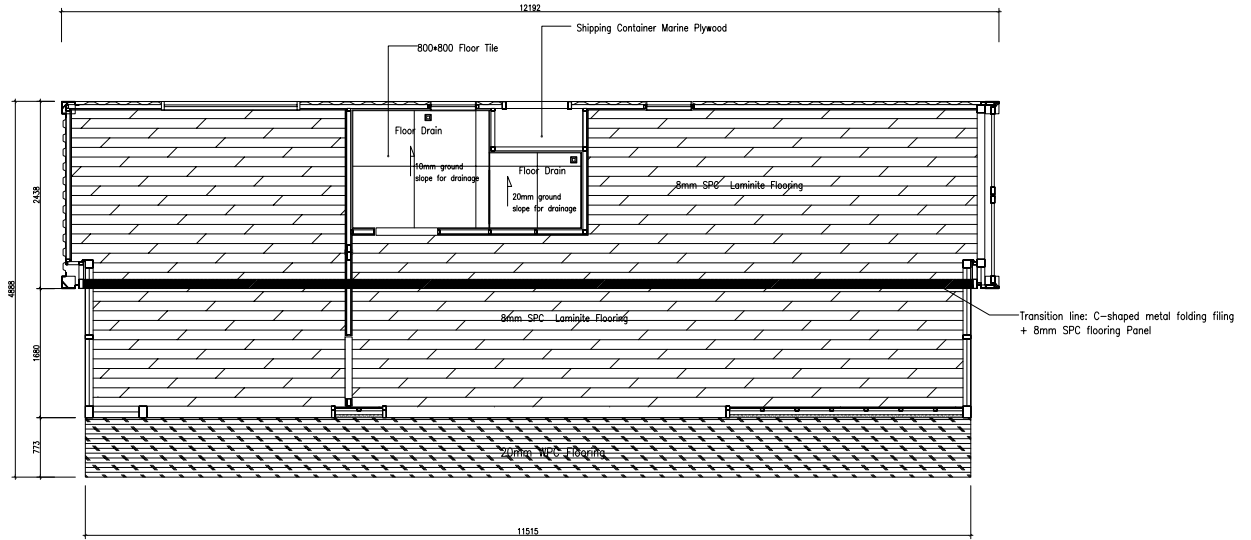

LAYOUT PLAN
Flooring SCALE 1:30

MH-002

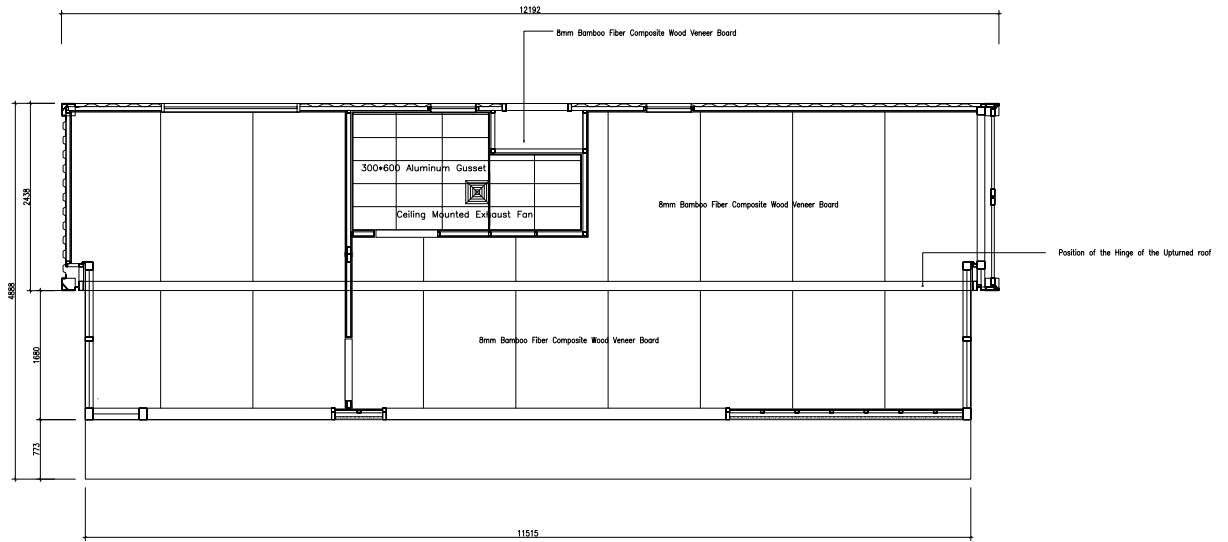

LAYOUT PLAN
 Ceiling SCALE 1:30

MH-003

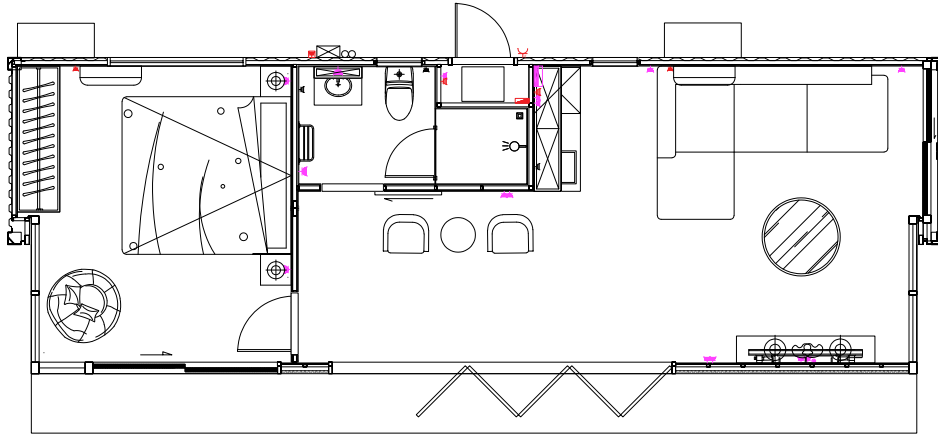

Electrical Plan
 Power Points SCALE 1:30

MH-005

Legend	Description
	240V 15A Simplex Outlet
	240V 10A Duplex Outlet
	ELV Box
	240V 10A Duplex Outlet with Waterproof Lid
	Electrical Panel - 63 Amp 2-SPACE
	Internet and TV Duplex Outlet
	60A Industrial Plug
	240V 15A Outdoor Simplex Outlet with Waterproof Lid

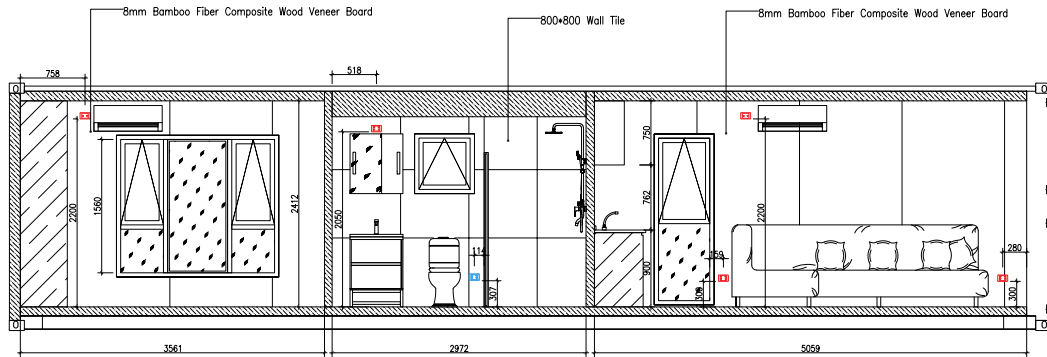

INTERIOR ELEVATION
Power Points Location (C Side) SCALE 1:30

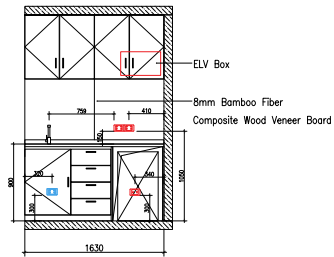

INTERIOR ELEVATION
Power Points Location (Kitchen Backwall) SCALE 1:30

MH-006

Icon	Description
	240V 10A Duplex Outlet
	240V 15A Simplex Outlet
	240V 10A Duplex Outlet with Waterproof Lid

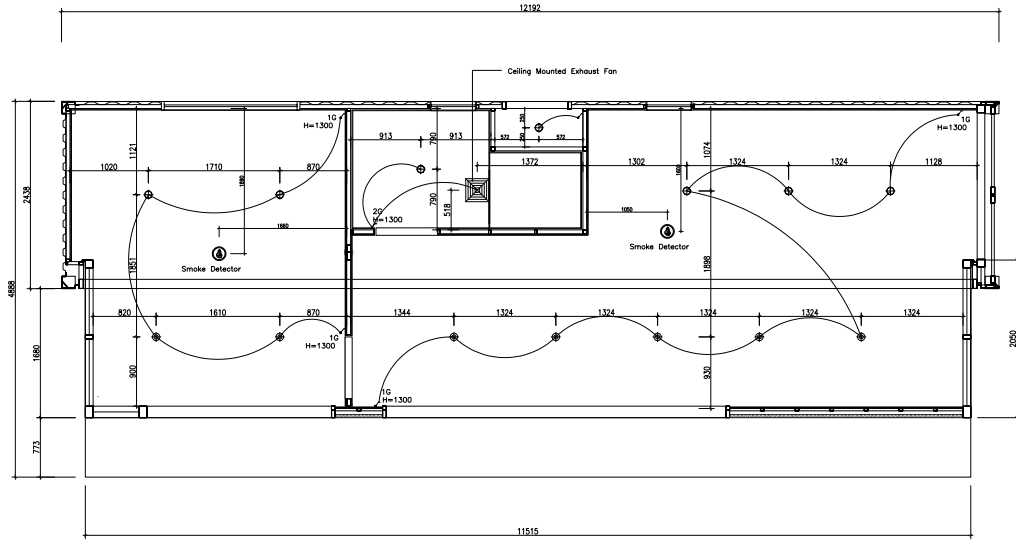

Electrical Plan
RCP SCALE 1:30

MH-007

Legend	Description
	Recessed L.E.D. Downlight
	Surface Mounted L.E.D. Downlight
	3-Way Switch
	1-Way Switch
	Ceiling Mounted Exhaust Fan
	Smoke Detector

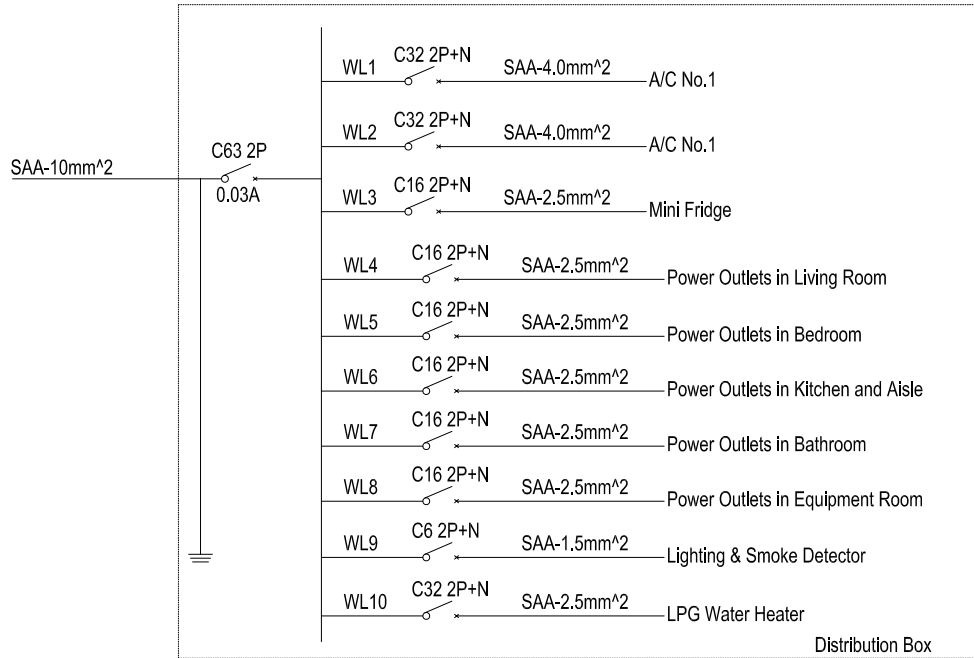

MH-008

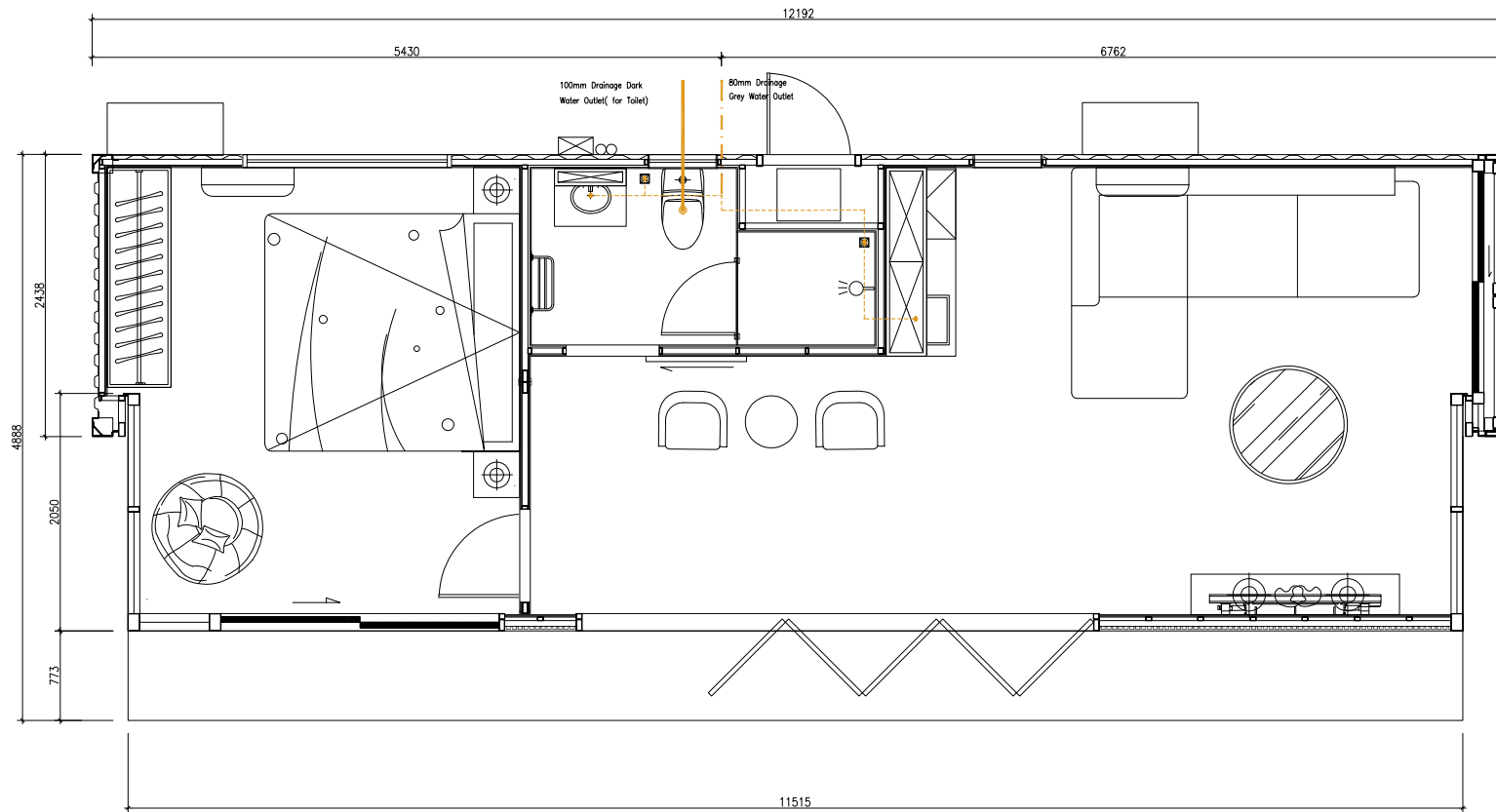

PLUMBING PLAN
 West Water Line SCALE 1:30

- 100mm WM PVC Drainage Pipe
- - - 80mm WM PVC Drainage Pipe
- · · 40mm WM PVC Drainage Pipe
- WM PVC Drainage Pipe

MH-009

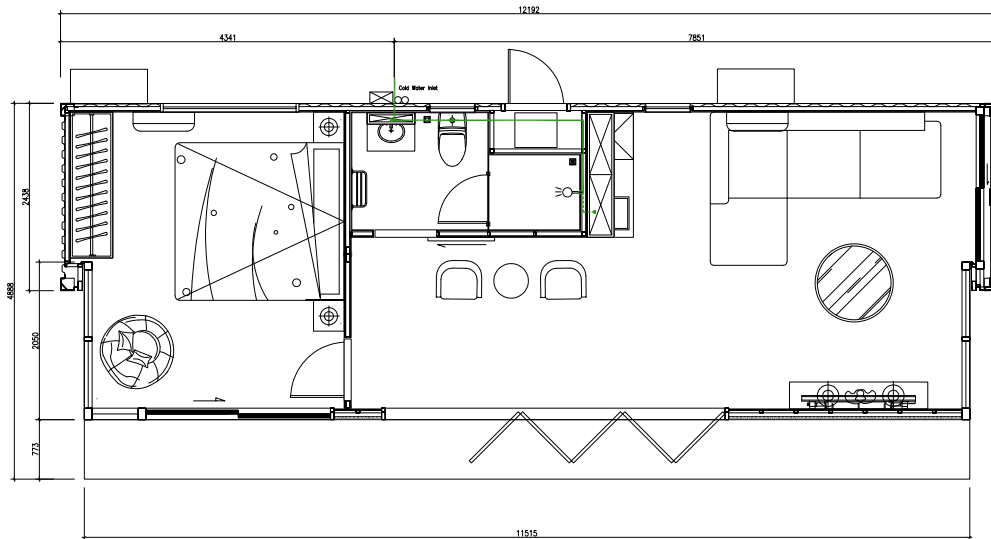

PLUMBING PLAN
Cold Water Supply SCALE 1:30

- 20mm WM PEX Cold Water Pipe
- 16mm WM PEX Cold Water Pipe
- 16mm WM PEX Cold Water Pipe

MH-010

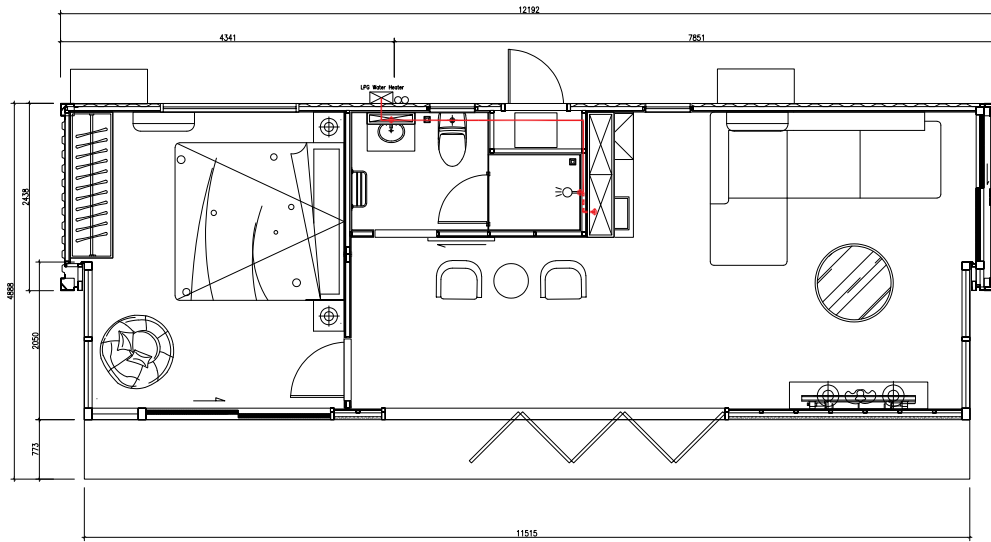

PLUMBING PLAN
Hot Water Supply SCALE 1:30

- 20mm WM PEX Hot Water Pipe
- - - 16mm WM PEX Hot Water Pipe
- 16mm WM PEX Hot Water Pipe

MH-011

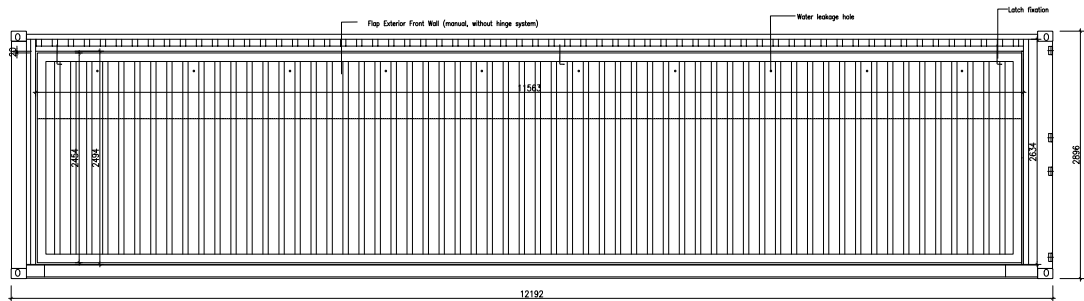

EXTERIOR ELEVATION

A Side (Close State)

SCALE 1:30

MH-012

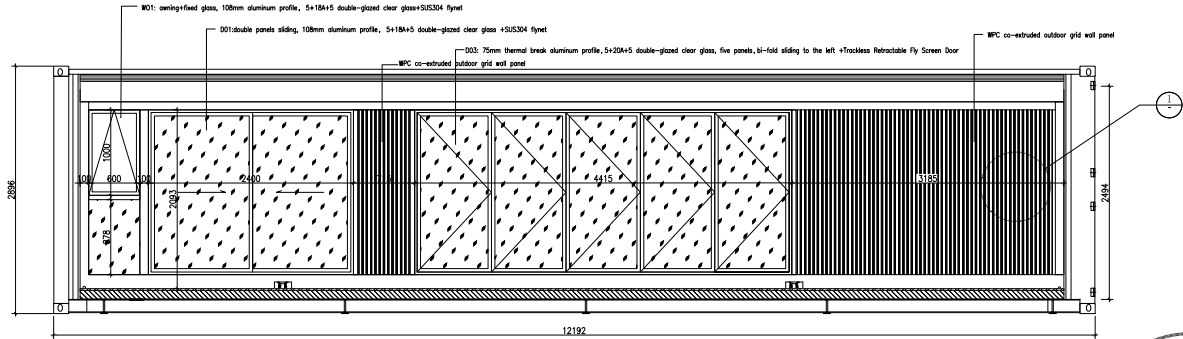

EXTERIOR ELEVATION
 A Side (Open State) SCALE 1:30

MH-013

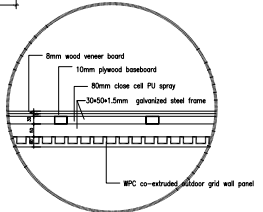

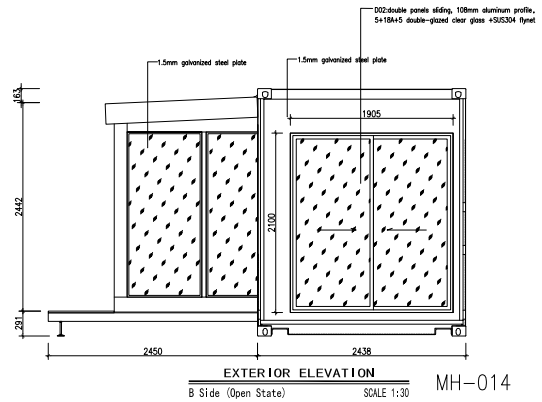
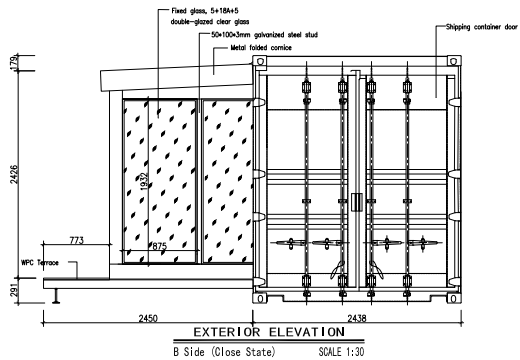

MH-014

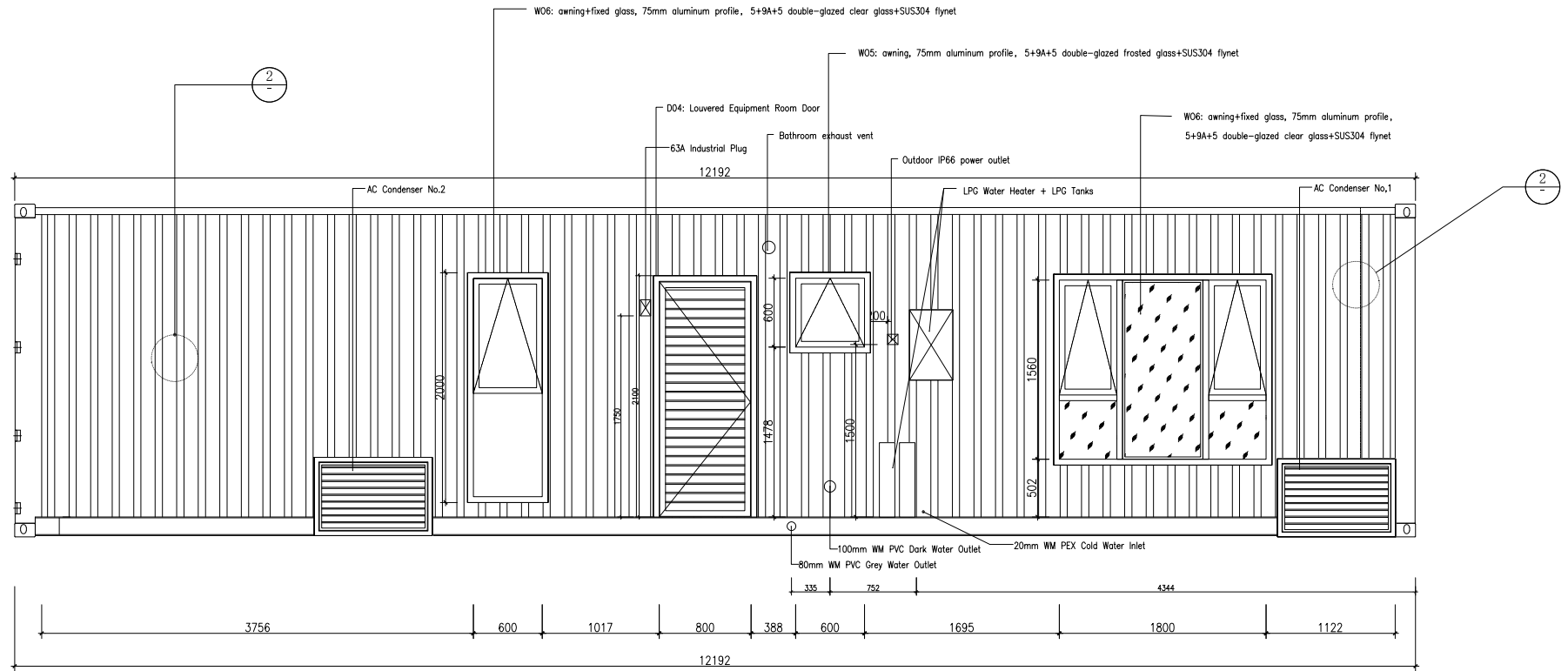

EXTERIOR ELEVATION
C Side SCALE 1:30

MH-015

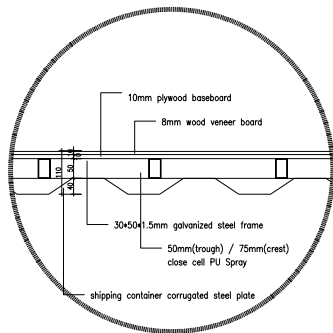

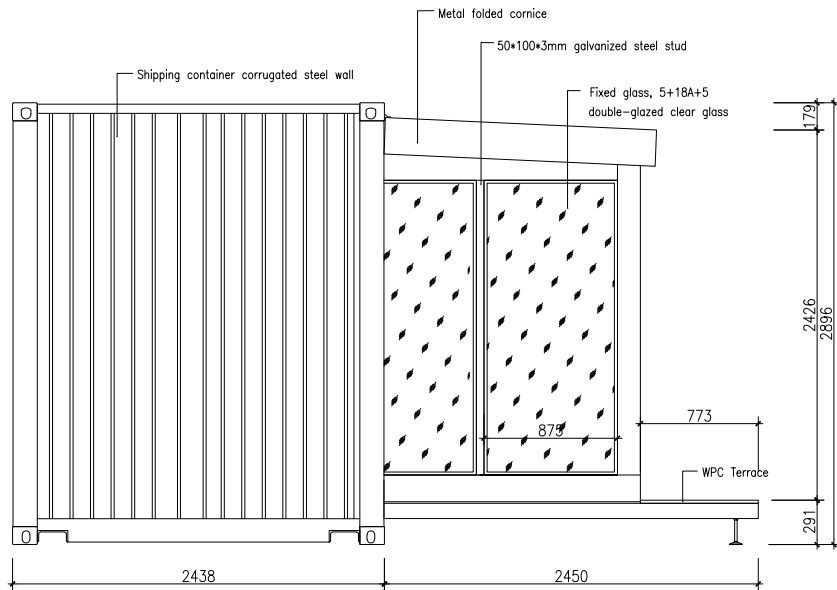

EXTERIOR ELEVATION

D Side

SCALE 1:30

MH-016

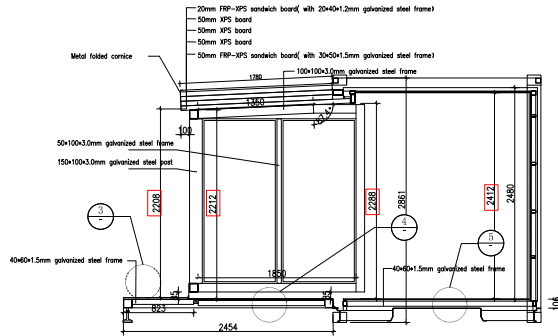

Cross Section
B-D Side Headroom SCALE 1:30

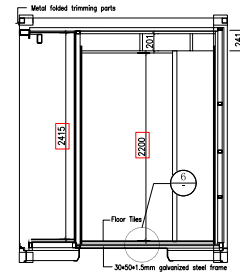

Cross Section
B-D Side Bathroom Headroom SCALE 1:30

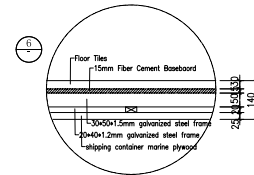
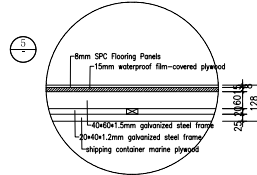
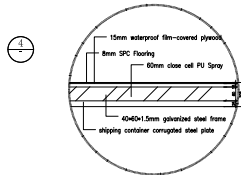
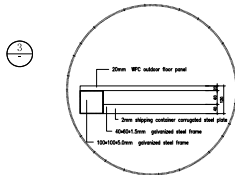

MH-017

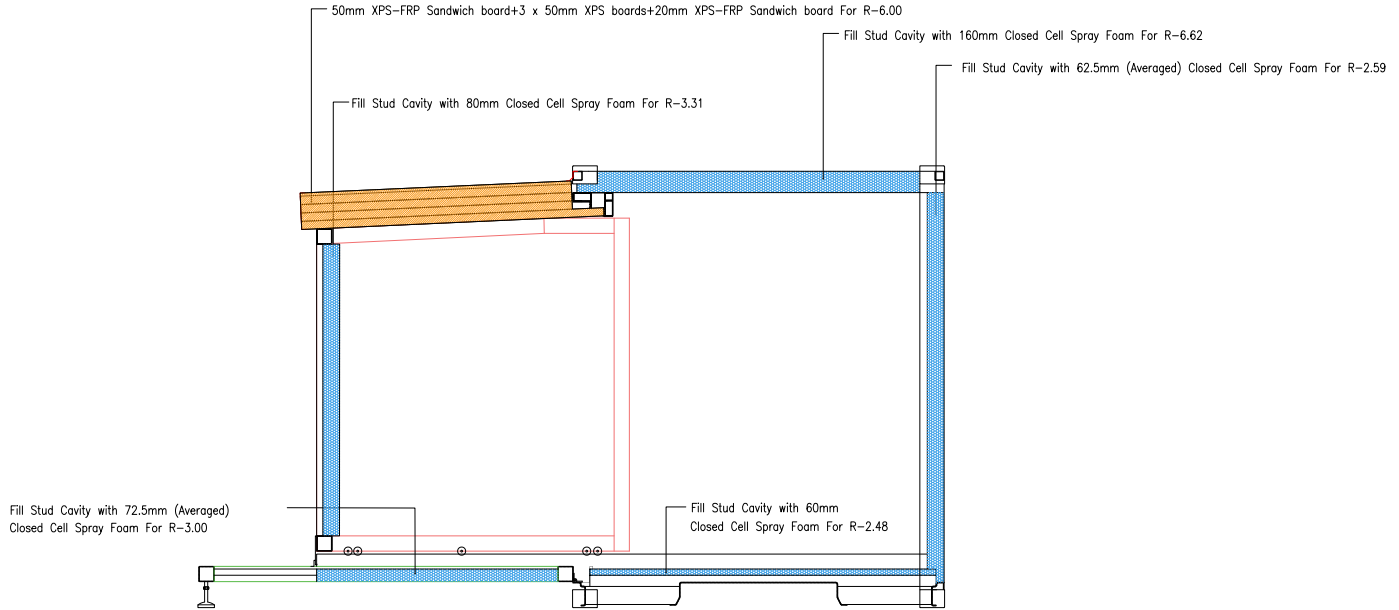

Cross Section

B-D Side Insulation Details SCALE 1:30

MH-018

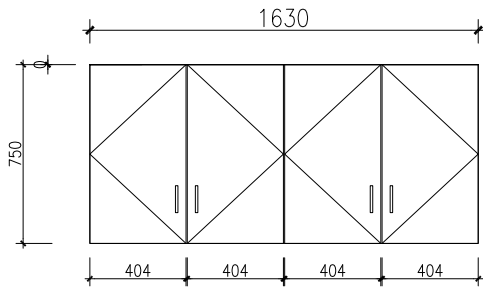

Overhead Cupboards
Front View

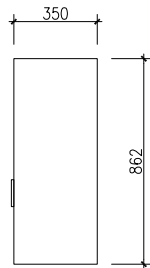

Overhead Cupboards
Side View

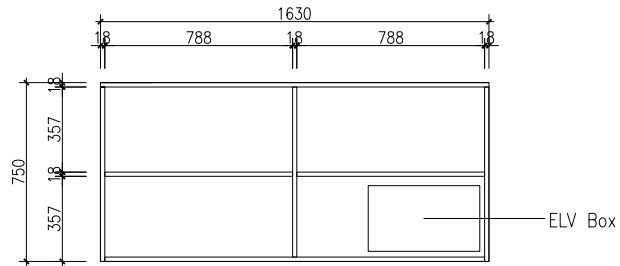

Overhead Cupboards
Inner Layout

MH-019

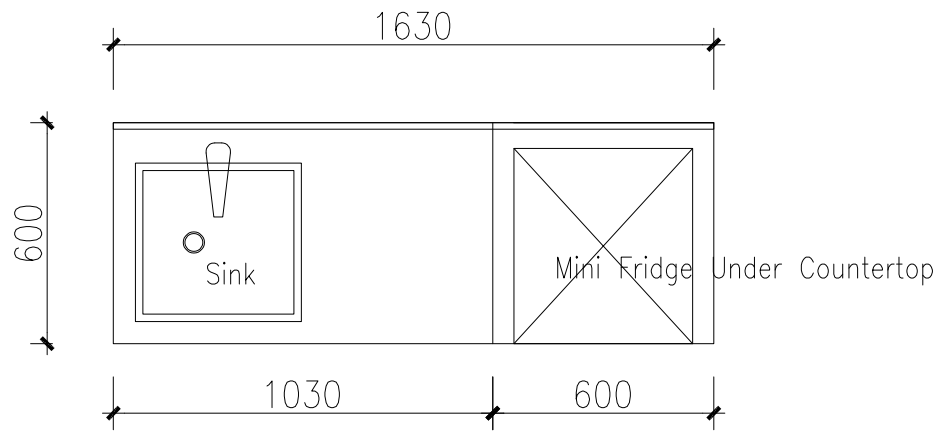

Kitchen Bench
Top View SCALE 1:30

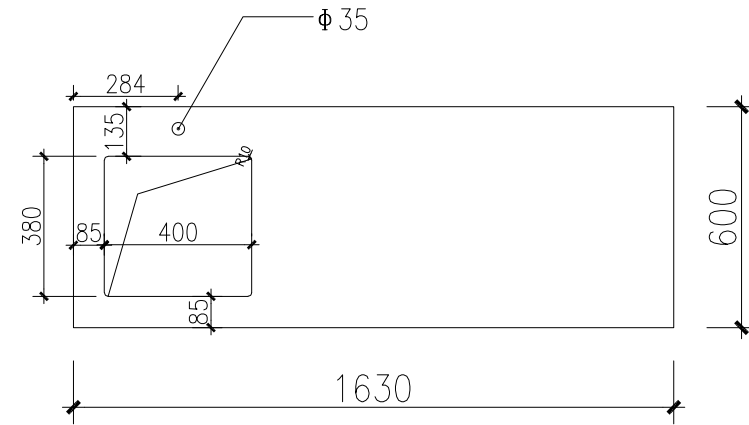

Kitchen Bench
Openings on quartz countertop SCALE 1:30

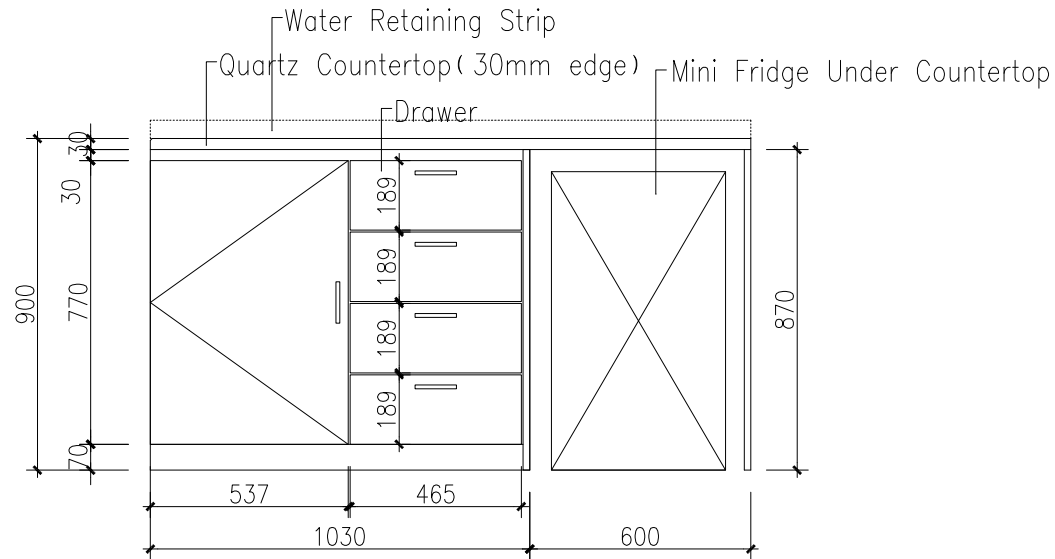

Kitchen Bench
Front View

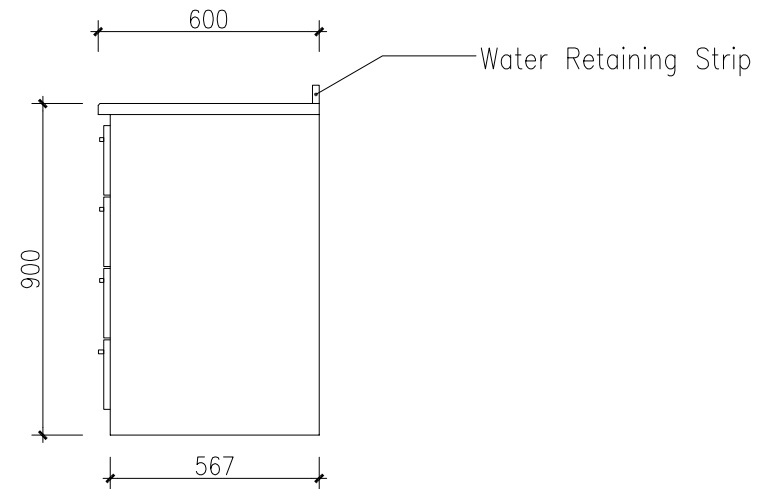

Kitchen Bench
Side View

MH-020

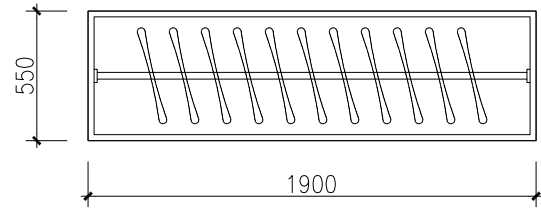

Closet

Top View SCALE 1:30

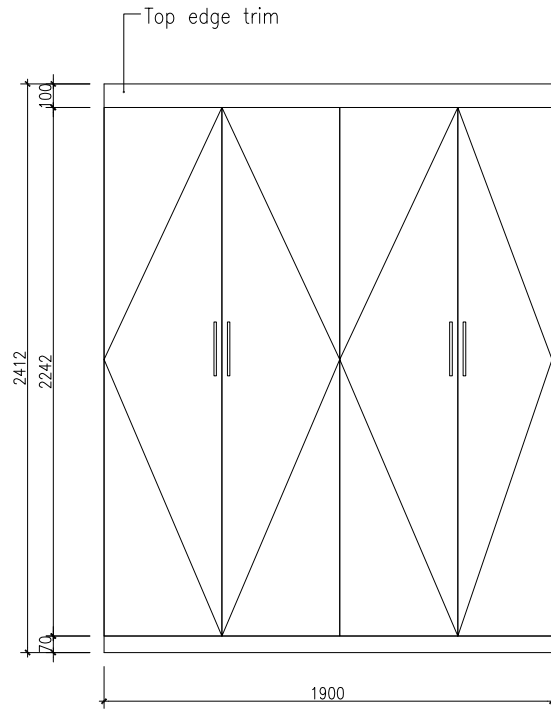

Closet

Front View SCALE 1:30

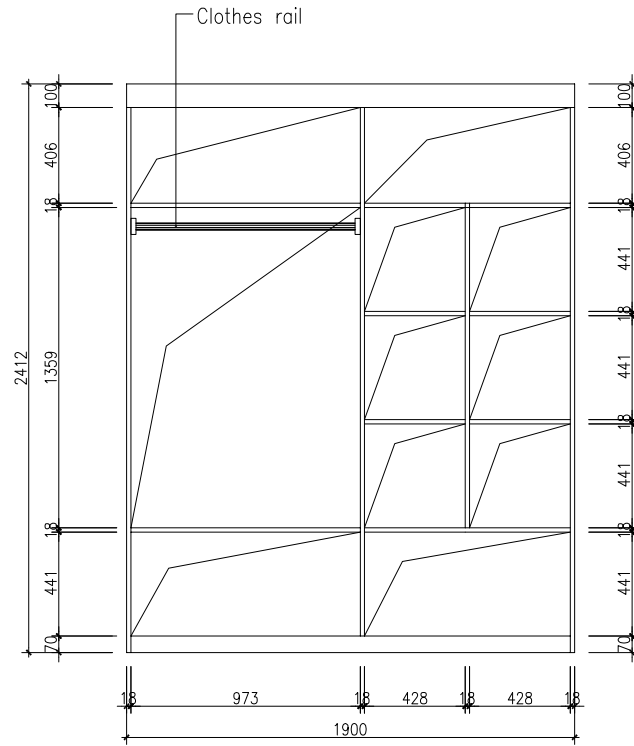

Closet

Inner Layout SCALE 1:30